

GATE Paper 2009

Q. No. 1 – 20 Carry One Mark Each

1. The pressure coil of a dynamometer type wattmeter is
 (A) highly inductive (B) highly resistive
 (C) purely resistive (D) purely inductive
2. The measurement system shown in the figure uses three sub-systems in cascade whose gains are specified as G_1 , G_2 and $\frac{1}{G_3}$. The relative small errors associated with each respective subsystem G_1 , G_2 and G_3 are ϵ_1 , ϵ_2 and ϵ_3 . The error associated with the output is:

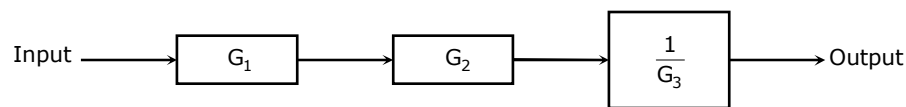

- (A) $\epsilon_1 + \epsilon_2 + \frac{1}{\epsilon_3}$ (B) $\frac{\epsilon_1 \cdot \epsilon_2}{\epsilon_3}$ (C) $\epsilon_1 + \epsilon_2 - \epsilon_3$ (D) $\epsilon_1 + \epsilon_2 + \epsilon_3$
3. The following circuit has a source voltage V_s as shown in the graph. The current through the circuit is also shown.

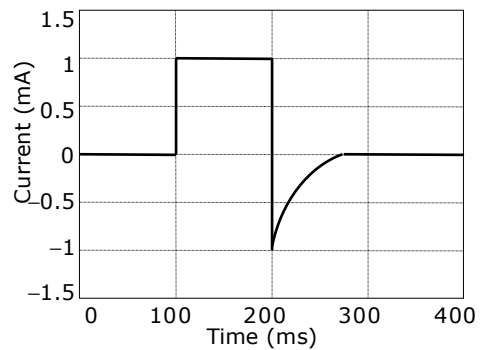
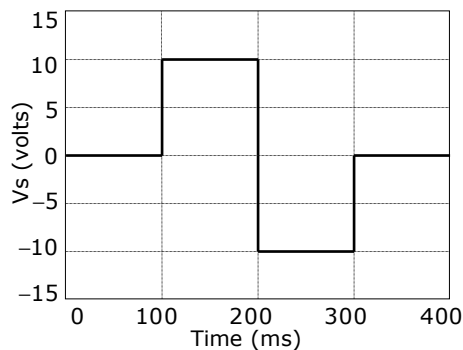
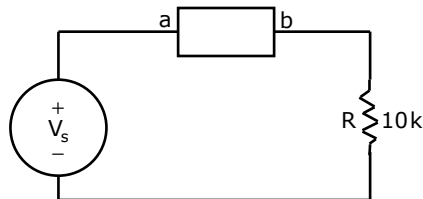

The element connected between a and b could be

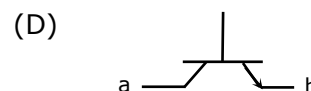
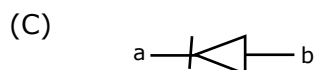
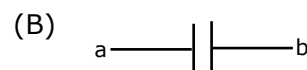
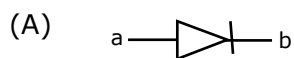

4. The two inputs of a CRO are fed with two stationary periodic signals. In the X-Y mode, the screen shows a figure which changes from ellipse to circle and back to ellipse with its major axis changing orientation slowly and repeatedly. The following inference can be made from this.
- (A) The signals are not sinusoidal
 (B) The amplitudes of the signals are very close but not equal
 (C) The signals are sinusoidal with their frequencies very close but not equal
 (D) There is a constant but small phase difference between the signals
5. The increasing order of speed of data access for the following devices is
- (i) Cache Memory
 (ii) CDROM
 (iii) Dynamic RAM
 (iv) Processor Registers
 (v) Magnetic Tape
- (A) (v), (ii), (iii), (iv), (i) (B) (v), (ii), (iii), (i), (iv)
 (C) (ii), (i), (iii), (iv), (v) (D) (v), (ii), (i), (iii), (iv)
6. A field excitation of 20 A in a certain alternator results in an armature current of 400A in short circuit and a terminal voltage of 2000V on open circuit. The magnitude of the internal voltage drop within the machine at a load current of 200A is
- (A) 1V (B) 10V (C) 100V (D) 1000V
7. The current through the 2 k Ω resistance in the circuit shown is

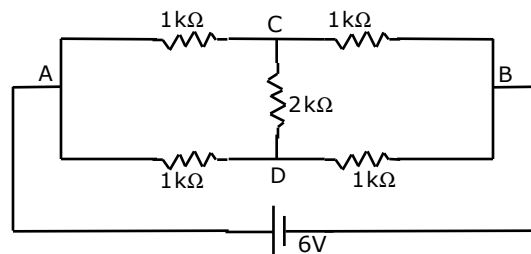

- (A) 0mA (B) 1mA (C) 2mA (D) 6mA
8. Out of the following plant categories
- (i) Nuclear (ii) Run-of-river (iii) Pump Storage (iv) Diesel
- The base load power plants are
- (A) (i) and (ii) (B) (ii) and (iii) (C) (i), (ii) and (iv) (D) (i), (iii) & (iv)
9. For a fixed value of complex power flow in a transmission line having a sending end voltage V , the real power loss will be proportional to
- (A) V (B) V^2 (C) $1/V^2$ (D) $1/V$

10. How many 200W/220V incandescent lamps connected in series would consume the same total power as a single 100W/220V incandescent lamp?
 (A) not possible (B) 4 (C) 3 (D) 2
11. A Linear Time Invariant system with an impulse response $h(t)$ produces output $y(t)$ when input $x(t)$ is applied. When the input $x(t - \tau)$ is applied to a system with impulse response $h(t - \tau)$, the output will be
 (A) $y(t)$ (B) $y(2(t - \tau))$ (C) $y(t - \tau)$ (D) $y(t - 2\tau)$

12. The nature of feedback in the opamp circuit shown is
 (A) Current - Current feedback

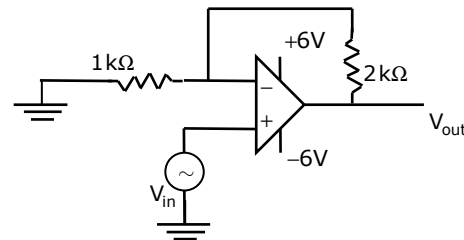

- (B) Voltage - Voltage feedback
 (C) Current - Voltage feedback
 (D) Voltage - Current feedback

13. The complete set of only those Logic Gates designated as Universal Gates is
 (A) NOT, OR and AND Gates (B) XNOR, NOR and NAND Gate
 (C) NOR and NAND Gates (D) XOR, NOR and NAND Gates

14. The single phase, 50Hz, iron core transformer in the circuit has both the vertical arms of cross sectional area 20cm^2 and both the horizontal arms of cross sectional area 10cm^2 . If the two windings shown were wound instead on opposite horizontal arms, the mutual inductance will
 (A) double
 (B) remain same
 (C) be halved
 (D) become one quarter

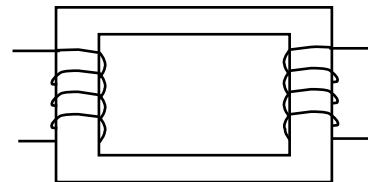

15. A 3-phase squirrel cage induction motor supplied from a balanced 3-phase source drives a mechanical load. The torque-speed characteristics of the motor (solid curve) and of the load (dotted curve) are shown. Of the two equilibrium points A and B, which of the following options correctly describes the stability of A and B?
 (A) A is stable B is unstable

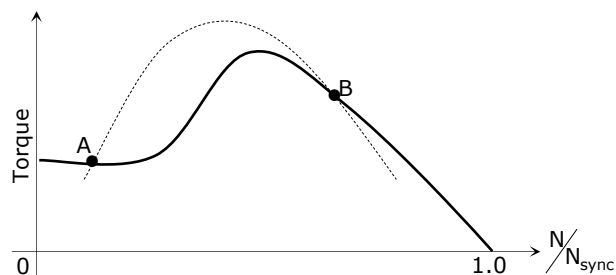

- (B) A is unstable B is stable
 (C) Both are stable
 (D) Both are unstable

16. An SCR is considered to be a semi-controlled device because
- it can be turned OFF but not ON with a gate pulse
 - it conducts only during one half-cycle of an alternating current wave
 - it can be turned ON but not OFF with a gate pulse
 - it can be turned ON only during one half-cycle of an alternating voltage wave

17. The polar plot of an open loop stable system is shown below. The closed loop system is

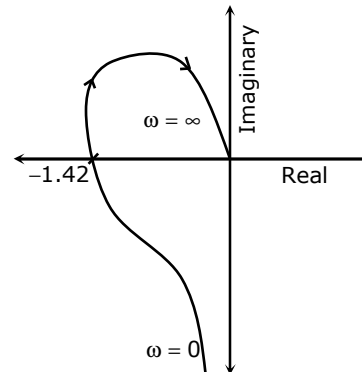

- Always stable
 - Marginally stable
 - Unstable with one pole on the RH s-plane
 - Unstable with two poles on the RH s-plane
18. The first two rows of Routh's tabulation of a third order equation are as follows.

$$\begin{array}{r} s^3 \quad 2 \quad 2 \\ s^2 \quad 4 \quad 4 \end{array}$$

This means there are

- two roots at $s = \pm j$ and one root in right half s-plane
 - two roots at $s = \pm j2$ and one root in left half s-plane
 - two roots at $s = \pm j2$ and one root in right half s-plane
 - two roots at $s = \pm j$ and one root in left half s-plane
19. The asymptotic approximation of the log-magnitude vs frequency plot of a system containing only real poles and zeros is shown. Its transfer function is

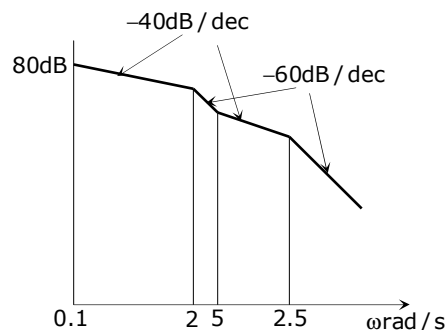

- $\frac{10(s+5)}{s(s+2)(s+25)}$
- $\frac{1000(s+5)}{s^2(s+2)(s+25)}$
- $\frac{100(s+5)}{s(s+2)(s+25)}$
- $\frac{80(s+5)}{s^2(s+2)(s+25)}$

20. The trace and determinant of a 2×2 matrix are known to be -2 and -35 respectively. Its eigen values are
 (A) -30 and -5 (B) -37 and -1 (C) -7 and 5 (D) 17.5 and -2

Q. No. 21 – 56 Carry Two Marks Each

21. The following circuit has $R = 10\text{k}\Omega$, $C = 10\mu\text{F}$. The input voltage is a sinusoid at 50Hz with an rms value of 10V . Under ideal conditions, the current i_s from the source is

- (A) $10\pi\text{mA}$ leading by 90°
 (B) $20\pi\text{mA}$ leading by 90°
 (C) 10mA leading by 90°
 (D) $10\pi\text{mA}$ lagging by 90°

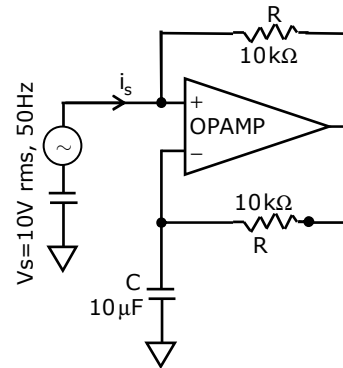

22. In the figure shown, all elements used are ideal. For time $t < 0$, S_1 remained closed and S_2 open. At $t = 0$, S_1 is opened and S_2 is closed. If the voltage V_{C_2} across the capacitor C_2 at $t = 0$ is zero, the voltage across the capacitor combination at $t = 0^+$ will be

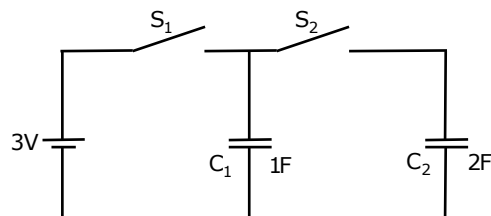

- (A) 1V (B) 2V (C) 1.5V (D) 3V
23. Transformer and emitter follower can both be used for impedance matching at the output of an audio amplifier. The basic relationship between the input power P_{in} and output power P_{out} in both the cases is
- (A) $P_{in} = P_{out}$ for both transformer and emitter follower
 (B) $P_{in} > P_{out}$ for both transformer and emitter follower
 (C) $P_{in} < P_{out}$ for transformer and $P_{in} = P_{out}$ for emitter follower
 (D) $P_{in} = P_{out}$ for transformer and $P_{in} < P_{out}$ for emitter follower

24. The equivalent capacitance of the input loop of the circuit shown is

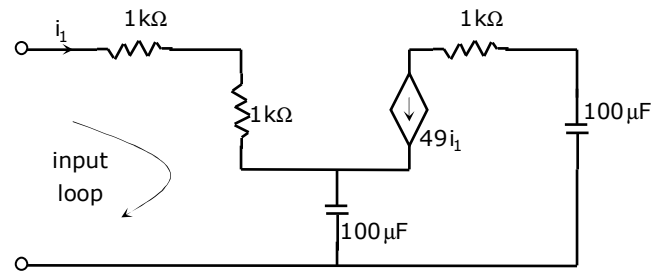

- (A) $2\mu\text{F}$ (B) $100\mu\text{F}$ (C) $200\mu\text{F}$ (D) $4\mu\text{F}$
25. In an 8085 microprocessor, the contents of the Accumulator, after the following
XRA A
instructions are executed will become MVIB F0H
SUB B
- (A) 01 H (B) 0F H (C) F0 H (D) 10 H
26. For the Y-bus matrix of a 4-bus system given in per unit, the buses having shunt
elements are $Y_{\text{BUS}} = j \begin{bmatrix} -5 & 2 & 2.5 & 0 \\ 2 & -10 & 2.5 & 4 \\ 2.5 & 2.5 & -9 & 4 \\ 0 & 4 & 4 & -8 \end{bmatrix}$
- (A) 3 and 4 (B) 2 and 3 (C) 1 and 2 (D) 1,2 and 4
27. The unit-step response of a unity feedback system with open loop transfer
function $G(s) = K/((s + 1)(s + 2))$ is shown in the figure. The value of K is

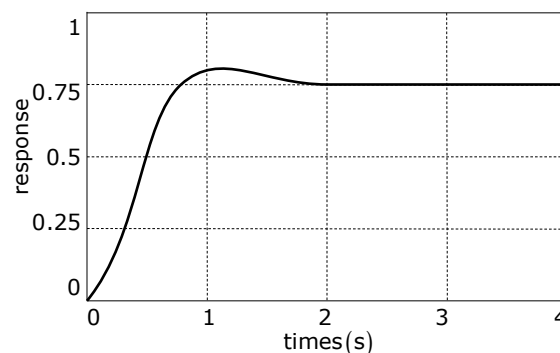

- (A) 0.5 (B) 2 (C) 4 (D) 6
28. The open loop transfer function of a unity feedback system is given by
 $G(s) = (e^{-0.1s})/s$. The gain margin of this system is
- (A) 11.95dB (B) 17.67dB (C) 21.33dB (D) 23.9dB

29. Match the items in List-I with the items in List-II and select the correct answer using the codes given below the lists.

List I

- To
- improve power factor
 - reduce the current ripples
 - increase the power flow in line
 - reduce the Ferranti effect
- (A) $a \rightarrow 2$ $b \rightarrow 3$ $c \rightarrow 4$ $d \rightarrow 1$
 (C) $a \rightarrow 4$ $b \rightarrow 3$ $c \rightarrow 1$ $d \rightarrow 2$

List II

- Use
- shunt reactor
 - shunt capacitor
 - series capacitor
 - series reactor
- (B) $a \rightarrow 2$ $b \rightarrow 4$ $c \rightarrow 3$ $d \rightarrow 1$
 (D) $a \rightarrow 4$ $b \rightarrow 1$ $c \rightarrow 3$ $d \rightarrow 2$

30. Match the items in List-I with the items in List-II and select the correct answer using the codes given below the lists.

List I

- Type of transmission line**
- Short Line
 - Medium Line
 - Long Line
- (A) $a \rightarrow 2$ $b \rightarrow 1$ $c \rightarrow 3$
 (C) $a \rightarrow 1$ $b \rightarrow 2$ $c \rightarrow 3$

List II

- Type of distance relay preferred**
- Ohm Relay
 - Reactance Relay
 - Mho Relay
- (B) $a \rightarrow 3$ $b \rightarrow 2$ $c \rightarrow 1$
 (D) $a \rightarrow 1$ $b \rightarrow 3$ $c \rightarrow 2$

31. Three generators are feeding a load of 100MW. The details of the generators are

	Rating(MW)	Efficiency (%)	Regulation (p.u.) on 100 MVA base
Generator-1	100	20	0.02
Generator-2	100	30	0.04
Generator-3	100	40	0.03

In the event of increased load power demand, which of the following will happen?

- (A) All the generators will share equal power
 (B) Generator-3 will share more power compared to Generator-1
 (C) Generator-1 will share more power compared to Generator-2
 (D) Generator-2 will share more power compared to Generator-3
32. A 500MW, 21kV,, 50Hz, 3-phase, 2-pole synchronous generator having a rated p.f=0.9, has a moment of inertia of 27.5×10^3 kg-m². The inertia constant (H) will be
 (A) 2.44s (B) 2.71s (C) 4.88s (D) 5.42s
33. $f(x,y)$ is a continuous function defined over $(x,y) \in [0,1] \times [0,1]$. Given the two constraints, $x > y^2$ and $y > x^2$, the volume under $f(x,y)$ is

- (A) $\int_{y=0}^{y=1} \int_{x=y^2}^{x=\sqrt{y}} f(x, y) dx dy$
- (B) $\int_{y=x^2}^{y=1} \int_{x=y^2}^{x=1} f(x, y) dx dy$
- (C) $\int_{y=0}^{y=1} \int_{x=0}^{x=1} f(x, y) dx dy$
- (D) $\int_{y=0}^{y=\sqrt{x}} \int_{x=0}^{x=\sqrt{y}} f(x, y) dx dy$
34. Assume for simplicity that N people, all born in April (a month of 30 days), are collected in a room. Consider the event of at least two people in the room being born on the same date of the month, even if in different years, e.g. 1980 and 1985. What is the smallest N so that the probability of this event exceeds 0.5?
- (A) 20 (B) 7 (C) 15 (D) 16
35. A cascade of 3 Linear Time Invariant systems is causal and unstable. From this, we conclude that
- (A) Each system in the cascade is individually causal and unstable
- (B) At least one system is unstable and at least one system is causal
- (C) At least one system is causal and all systems are unstable
- (D) The majority are unstable and the majority are causal
36. The Fourier Series coefficient, of a periodic signal $x(t)$, expressed as $x(t) = \sum_{k=-\infty}^{\infty} a_k e^{j2\pi kt/T}$ are given by $a_{-2} = 2 - j1$; $a_{-1} = 0.5 + j0.2$; $a_0 = j2$; $a_1 = 0.5 - j0.2$; $a_2 = 2 + j1$; and $a_k = 0$; for $|k| > 2$. Which of the following is true?
- (A) $x(t)$ has finite energy because only finitely many coefficients are non-zero
- (B) $x(t)$ has zero average value because it is periodic
- (C) The imaginary part of $x(t)$ is constant
- (D) The real part of $x(t)$ is even
37. The z-transform of a signal $x[n]$ is given by $4z^{-3} + 3z^{-1} + 2 - 6z^2 + 2z^3$. It is applied to a system, with a transfer function $H(z) = 3z^{-1} - 2$. Let the output be $y(n)$. Which of the following is true?
- (A) $y(n)$ is non causal with finite support
- (B) $y(n)$ is causal with infinite support
- (C) $y(n) = 0; |n| > 3$
- (D) $\text{Re}[Y(z)]_{z=e^{j\theta}} = -\text{Re}[Y(z)]_{z=e^{-j\theta}}$; $\text{Im}[Y(z)]_{z=e^{j\theta}} = \text{Im}[Y(z)]_{z=e^{-j\theta}}$; $-\pi \leq \theta < \pi$
38. A cubic polynomial with real coefficients
- (A) can possibly have no extrema and no zero crossings
- (B) may have up to three extrema and up to 2 zero crossings

- (C) cannot have more than two extrema and more than three zero crossings
 (D) will always have an equal number of extrema and zero crossings

39. Let $x^2 - 117 = 0$. The iterative steps for the solution using Newton-Raphson's method is given by

(A) $x_{k+1} = \frac{1}{2} \left(x_k + \frac{117}{x_k} \right)$

(B) $x_{k+1} = x_k - \frac{117}{x_k}$

(C) $x_{k+1} = x_k - \frac{x_k}{117}$

(D) $x_{k+1} = x_k - \frac{1}{2} \left(x_k + \frac{117}{x_k} \right)$

40. $F(x, y) = (x^2 + xy)\hat{a}_x + (y^2 + xy)\hat{a}_y$. It's line integral over the straight line from $(x, y) = (0, 2)$ to $(x, y) = (2, 0)$ evaluates to

(A) -8

(B) 4

(C) 8

(D) 0

41. An ideal opamp circuit and its input waveform are shown in the figures. The output waveform of this circuit will be

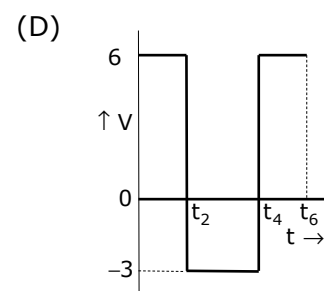
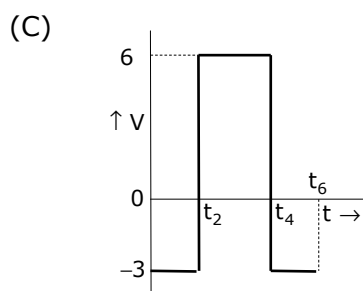
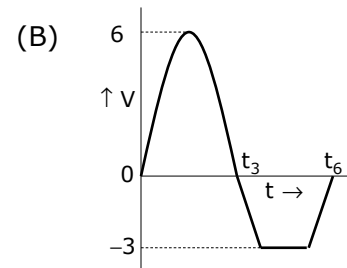
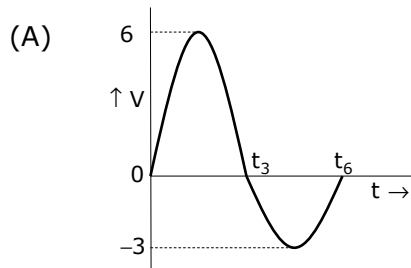
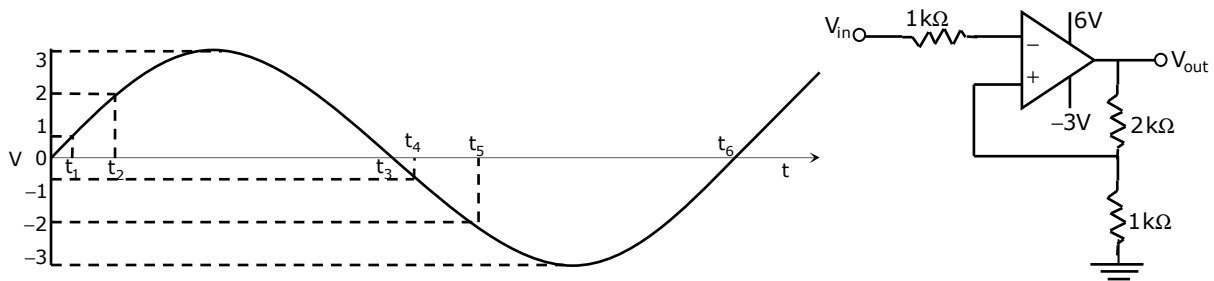

42. A 220V, 50Hz, single-phase induction motor has the following connection diagram and winding orientations shown. MM' is the axis of the main stator winding (M_1M_2) and AA' is that of the auxiliary winding (A_1A_2). Directions of the winding axes indicate direction of flux when currents in the windings are in the directions shown. Parameters of each winding are indicated. When switch S is closed, the motor
- (A) rotates clockwise
 (B) rotates anticlockwise
 (C) does not rotate
 (D) rotates momentarily and comes to a halt

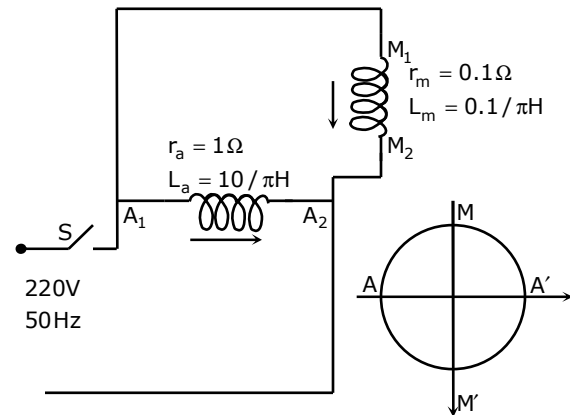

43. The circuit shows an ideal diode connected to a pure inductor and is connected to a purely sinusoidal 50Hz voltage source. Under ideal conditions the current waveform through the inductor will look like

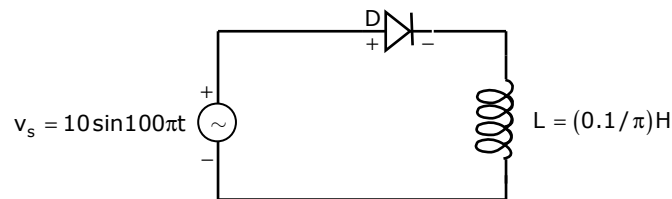

- (A)
- (B)
- (C)

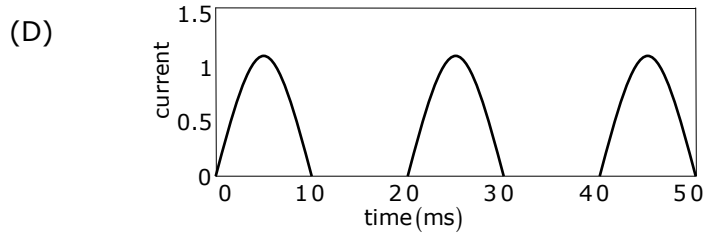

44. The Current Source Inverter shown in figure, is operated by alternately turning on thyristor pairs (T_1, T_2) and (T_3, T_4). If the load is purely resistive, the theoretical maximum output frequency obtainable will be

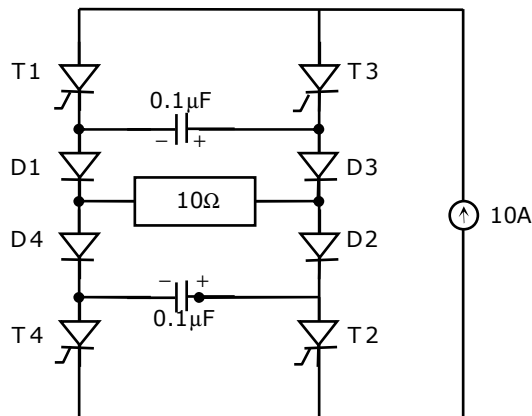

- (A) 125kHz (B) 250kHz (C) 500kHz (D) 50kHz
45. In the chopper circuit shown, the main thyristor (T_M) is operated at a duty ratio of 0.8, which is much larger the commutation interval. If the maximum allowable reapplied dv/dt on T_M is $50 \text{ V}/\mu\text{s}$, what should be the theoretical minimum value of C_1 ? Assume current ripple through L_o to be negligible.

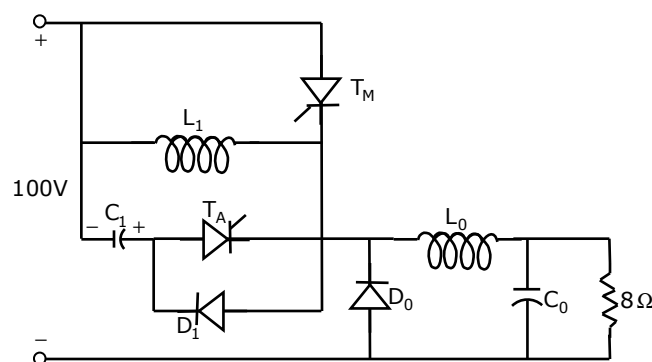

- (A) $0.2 \mu\text{F}$ (B) $0.02 \mu\text{F}$ (C) $2 \mu\text{F}$ (D) $20 \mu\text{F}$
46. Match the switch arrangements on the top row to the steady-state V-I characteristics on the lower row. The steady state operating points are shown by large black dots

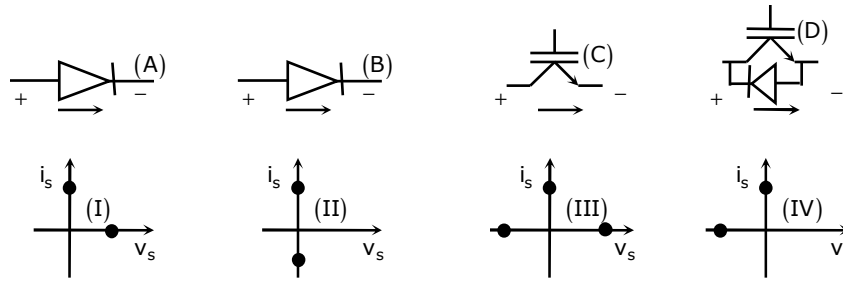

- (A) A – I B – II C – III D – IV
 (B) A – II B – IV C – I D – III
 (C) A – IV B – III C – I D – II
 (D) A – IV B – III C – II D – I

47. For the circuit shown, find out the current flowing through the 2Ω resistance. Also identify the changes to be made to double the current through the 2Ω resistance

- (A) (5A; Put $V_s = 20V$)
 (B) (2A; Put $V_s = 8V$)
 (C) (5A; Put $I_s = 10A$)
 (D) (7A; Put $I_s = 12A$)

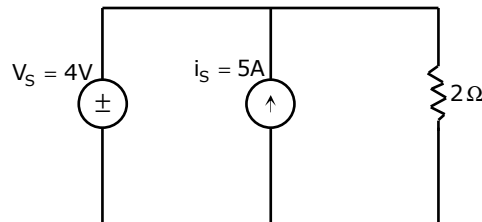

48. The figure shows a three-phase delta connected load supplied from a 400V, 50 Hz, 3-phase balanced source. The pressure coil (PC) and current coil (CC) of a wattmeter are connected to the load as shown, with the coil polarities suitably selected to ensure a positive deflection. The wattmeter reading will be

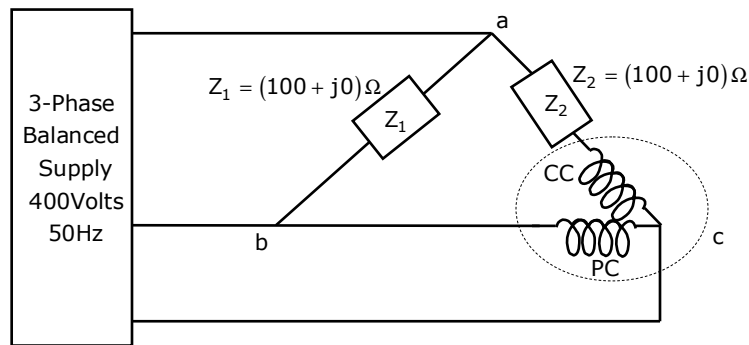

- (A) 0 (B) 1600 Watt (C) 800 Watt (D) 400 Watt

49. An average-reading digital multimeter reads 10V when fed with a triangular wave, symmetric about the time-axis. For the same input an rms-reading meter will read.

- (A) $20/\sqrt{3}$ (B) $10/\sqrt{3}$ (C) $20\sqrt{3}$ (D) $10\sqrt{3}$

50. Figure shows the extended view of a 2 pole dc machine with 10 armature conductors. Normal brush positions are shown by A and B, placed at the interpolar axis. If the brushes are now shifted, in the direction of rotation, to A' and B' as shown, the voltage waveform $V_{A'B'}$ will resemble

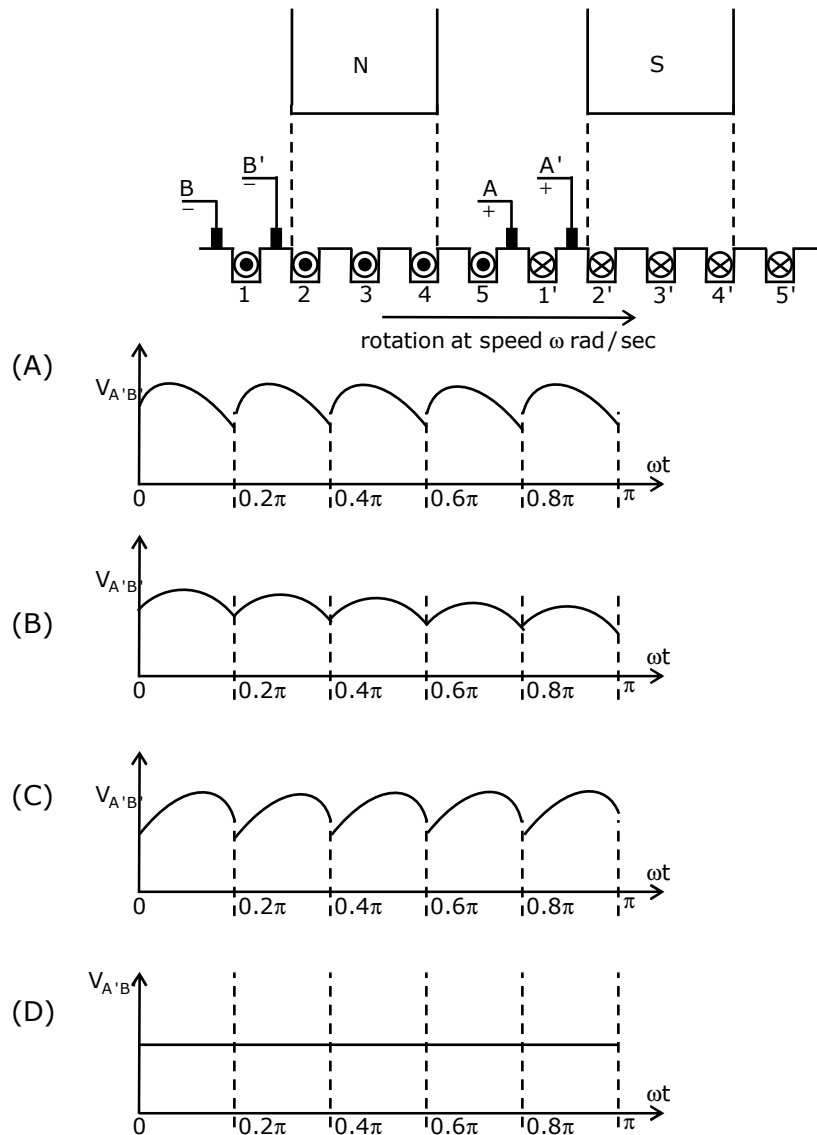

Common Data Questions: 51 & 52

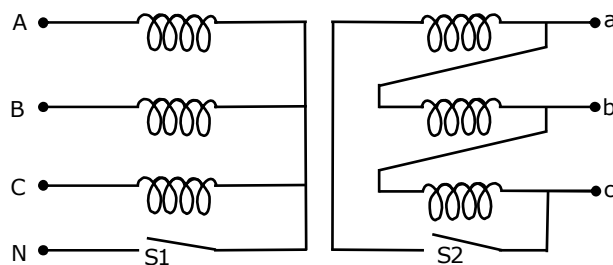

- The star-delta transformer shown above is excited on the star side with a balanced, 4-wire, 3-phase, sinusoidal voltage supply of rated magnitude. The transformer is under no load condition.
51. With both S1 and S2 open, the core flux waveform will be
 (A) A sinusoid at fundamental frequency (B) Flat topped with third harmonic
 (C) Peaky with third harmonic (D) None of these
52. With S2 closed and S1 open, the current waveform in the delta winding will be
 (A) a sinusoid at fundamental frequency (B) flat topped with third harmonic
 (C) only third harmonic (D) none of these

Common Data Questions: 53 & 54

The circuit diagram shows a two winding, lossless transformer with no leakage flux, excited from a current source, $i(t)$, whose waveform is also shown. The transformer has a magnetizing inductance of $400/\pi$ mH.

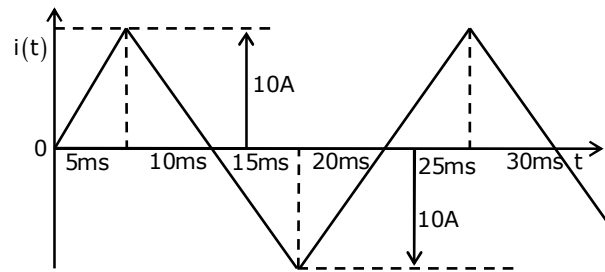
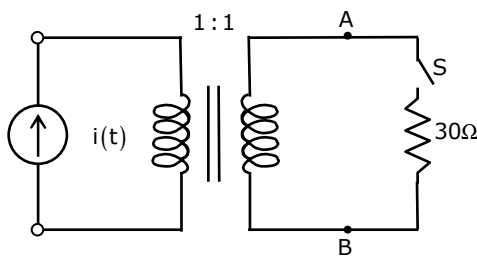

53. The peak voltage across A and B, with S open is
 (A) $400/\pi$ V (B) 800V (C) $4000/\pi$ V (D) $800/\pi$ V
54. If the waveform of $i(t)$ is changed to $i(t) = 10 \sin(100\pi t)$ A, the peak voltage across A and B with S closed is
 (A) 400V (B) 240V (C) 320V (D) 160V

Common Data Questions: 55 & 56

A system is described by the following state and output equations

$$\frac{dx_1(t)}{dt} = -3x_1(t) + x_2(t) + 2u(t)$$

$$\frac{dx_2(t)}{dt} = -2x_2(t) + u(t)$$

$$y(t) = x_1(t)$$

where $u(t)$ is the input and $y(t)$ is the output

55. The system transfer function is

- (A) $\frac{s+2}{s^2+5s-6}$ (B) $\frac{s+3}{s^2+5s+6}$ (C) $\frac{s+5}{s^2+5s+6}$ (D) $\frac{2s-5}{s^2+5s-6}$

56. The state transition matrix of the above system is

- (A) $\begin{bmatrix} e^{-3t} & 0 \\ e^{-2t} + e^{-3t} & e^{-2t} \end{bmatrix}$ (B) $\begin{bmatrix} e^{-3t} & e^{-2t} - e^{-3t} \\ 0 & e^{-2t} \end{bmatrix}$
 (C) $\begin{bmatrix} e^{-3t} & e^{-2t} + e^{-3t} \\ 0 & e^{-2t} \end{bmatrix}$ (D) $\begin{bmatrix} e^{3t} & e^{-2t} - e^{-3t} \\ 0 & e^{-2t} \end{bmatrix}$

Linked Answer Questions: Q.57 to Q.60 Carry Two Marks Each

Statement for Linked Answer Questions: 57 & 58

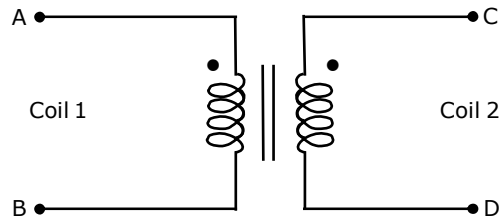

The figure above shows coils 1 and 2, with dot markings as shown, having 4000 and 6000 turns respectively. Both coils have a rated current of 25A. Coil 1 is excited with single phase, 400V, 50Hz supply

57. The coils are to be connected to obtain a single phase, 400/1000V, auto transformer to drive a load of 10kVA. Which of the options given should be exercised to realize the required auto transformer?
 (A) Connect A and D; Common B (B) Connect B and D; Common C
 (C) Connect A and C; Common B (D) Connect A and C; Common D
58. In the autotransformer obtained in Question 57, the current in each coil is
 (A) Coil-1 is 25 A and Coil-2 is 10 A (B) Coil-1 is 10 A and Coil-2 is 25 A
 (C) Coil-1 is 10 A and Coil-2 is 15 A (D) Coil-1 is 15 A and Coil-2 is 10 A

Statement for Linked Answer Questions: 59 & 60

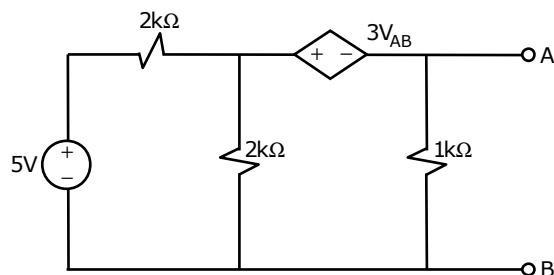

59. For the circuit given above, the Thevenin's resistance across the terminals A and B is
(A) $0.5k\Omega$ (B) $0.2k\Omega$ (C) $1k\Omega$ (D) $0.11k\Omega$
60. For the circuit given above, the Thevenin's voltage across the terminals A and B is
(A) $1.25V$ (B) $0.25V$ (C) $1V$ (D) $0.5V$